

COUPE A-A

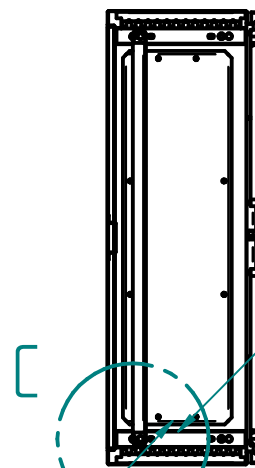

Matière inox 304L ou 316L svt demande client
 finition microbillée ou peint svt demande client

DETAIL C

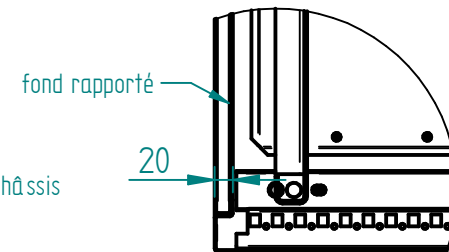

Socle INOX 316L en option

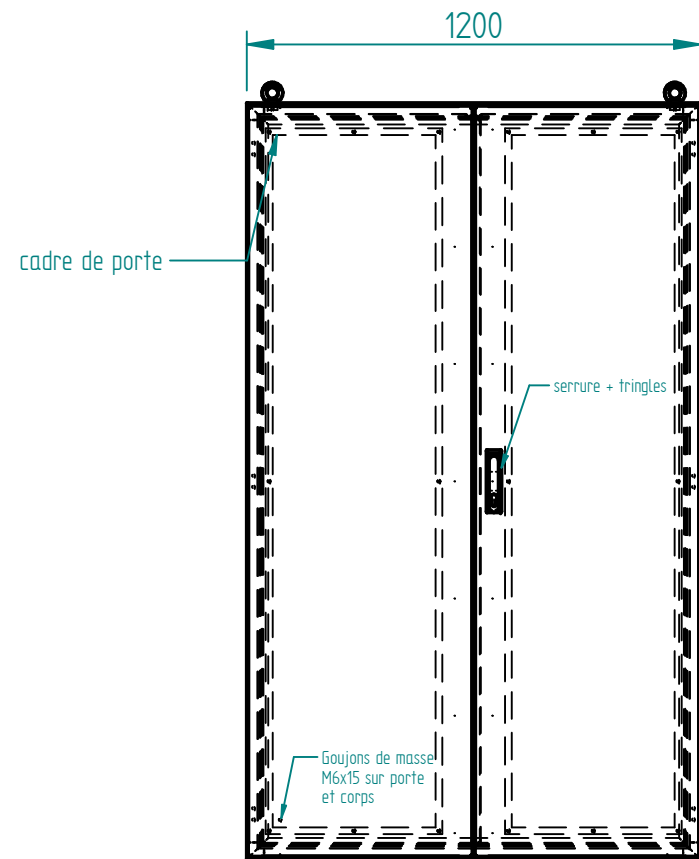
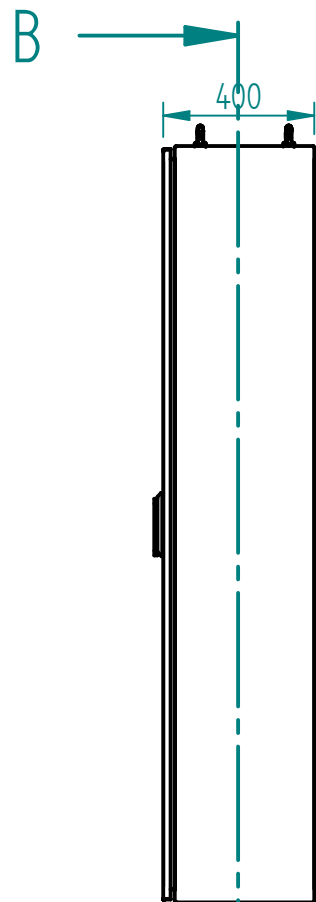

Plaque passe cable

anneaux de levage en option

COUPE B-B

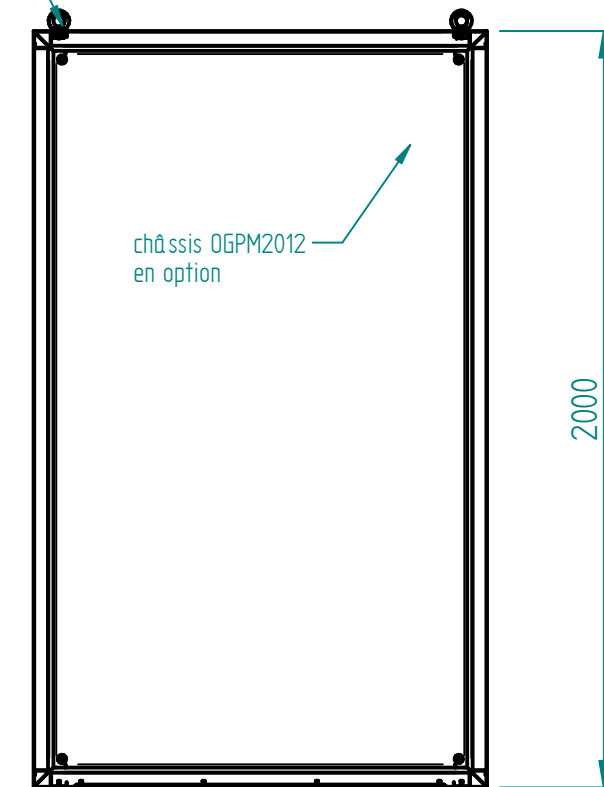
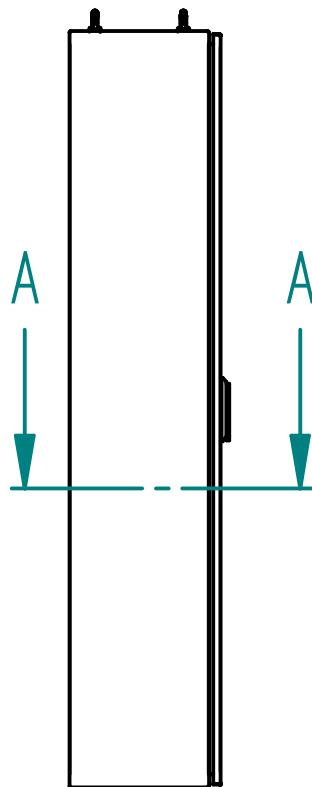

châssis OGPM2012 en option

2000

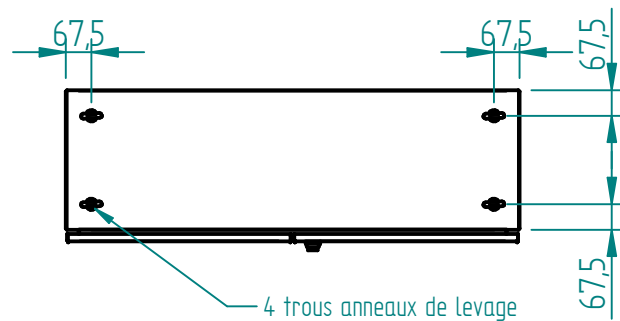

Joint EPDM extrudé 20x11 intérieur porte

A	CERVERA	01/03/19	Création
Ind	Nom	Date	Commentaires
Matière :		Nom du projet :	
Echelle : 1:20		Feuille : 1 / 1	
MARBORE		Document n° : AXDM201240 ou AYDM201240	
		Client :	
		Document n° : AXDM201240 ou AYDM201240	

ARM-MONO-2000x1200x400