

Socle INOX 316L en option

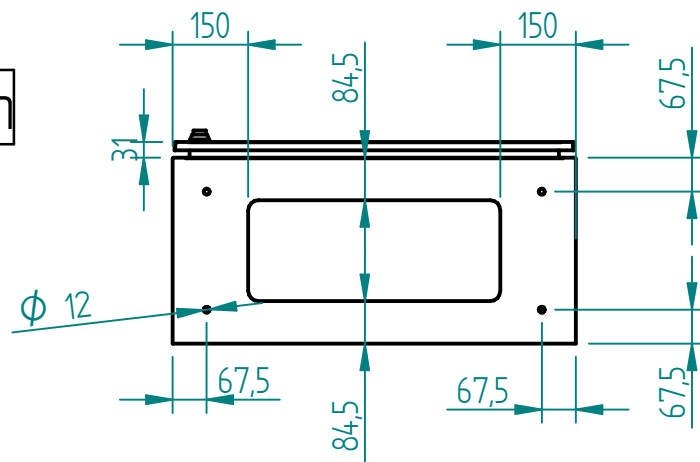

COUPE A-A

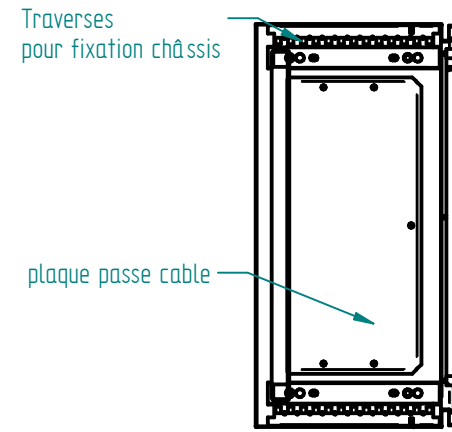

Matière inox 304L ou 316L svt demande client
 finition microbillée ou peint svt demande client

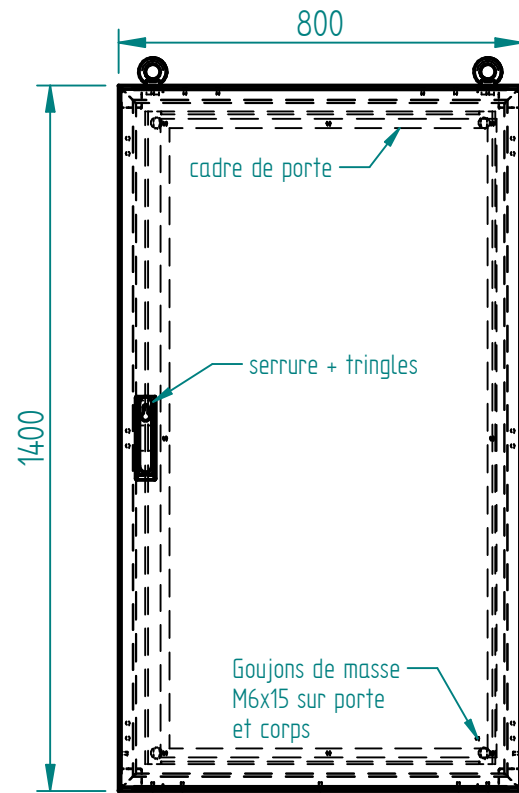
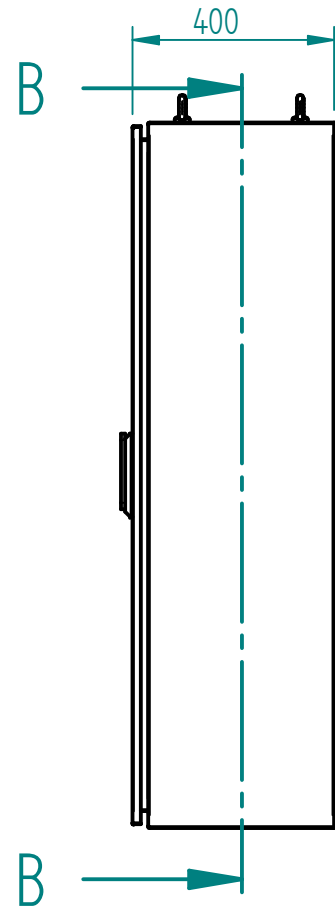

COUPE B-B

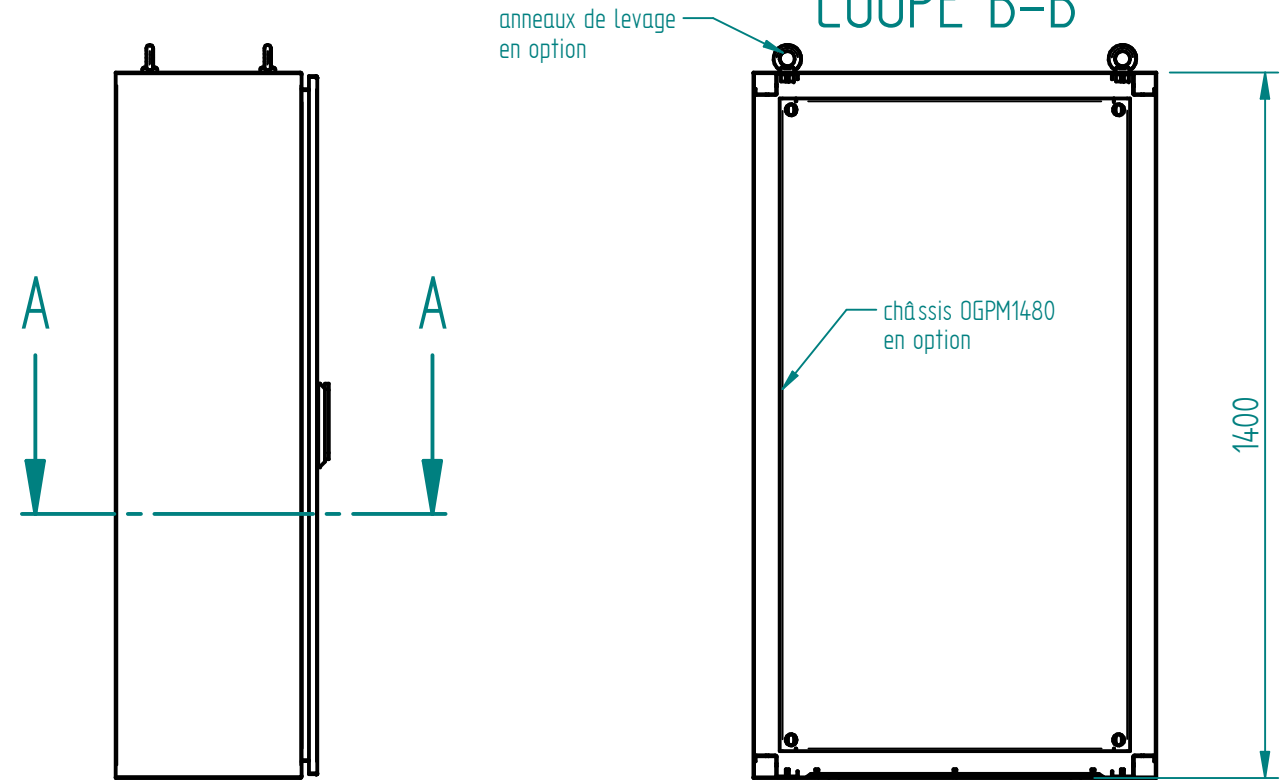

Joint EPDM extrudé 20x11 intérieur porte

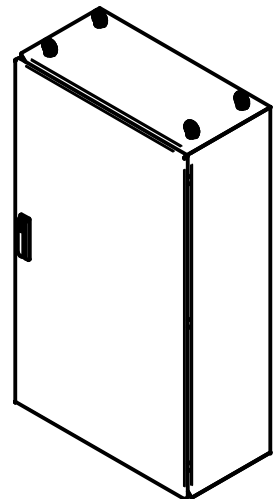
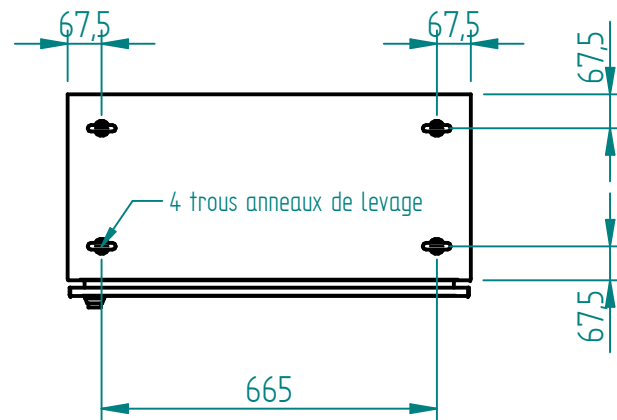

A	CERVERA	25/02/19	Création
Ind	Nom	Date	Commentaires
Matière :		Nom du projet :	
Echelle : 1:15		Feuille : 1 / 1	
		Client :	
MARBORE		Document n° : AXPM148040 ou AYPM148040	
ARM-MONO-1400X800X400			