

COUPE A-A

Traverses pour fixation châssis

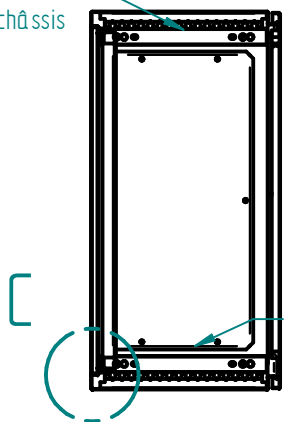

DETAIL C

fond rapporté

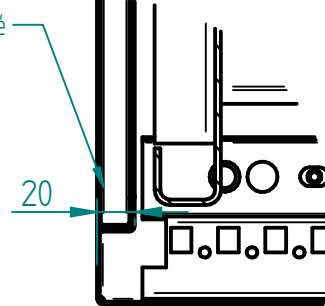

Matière inox 304L ou 316L svt demande client  
 finition microbillée ou peint svt demande client

Socle INOX 316L en option

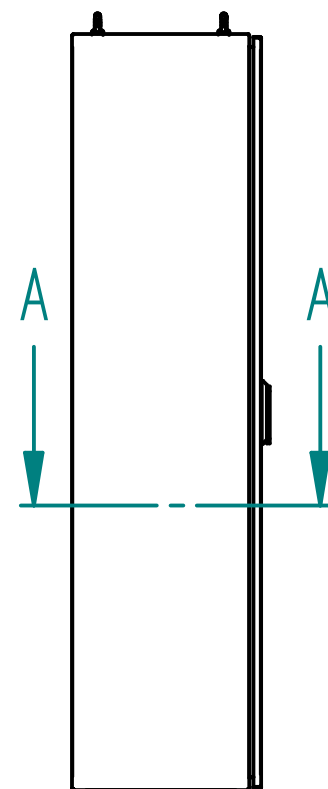
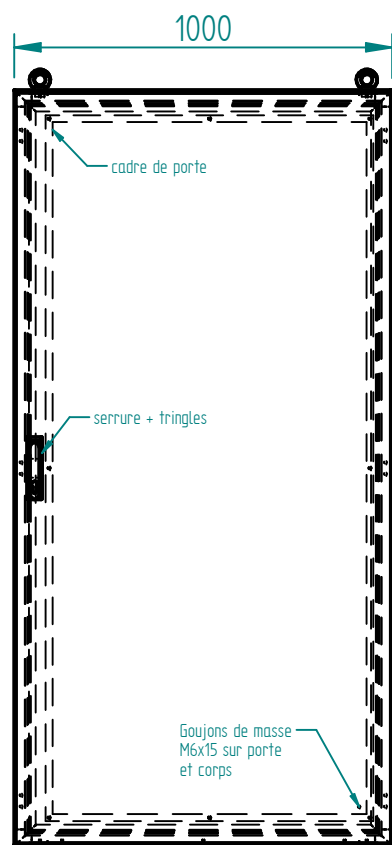
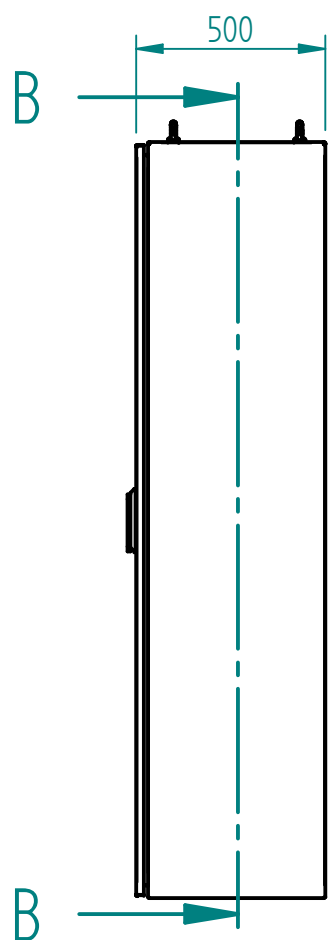

anneaux de levage en option

COUPE B-B

châssis OGPM2010 en option

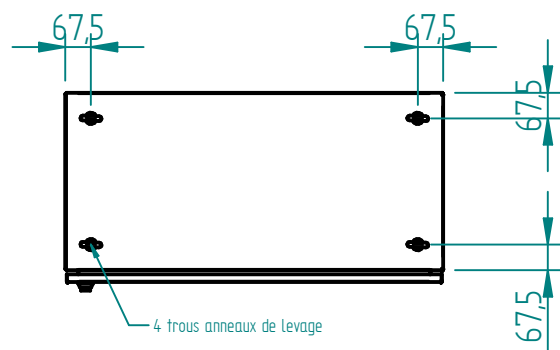
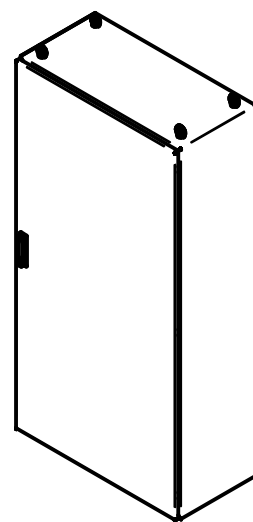
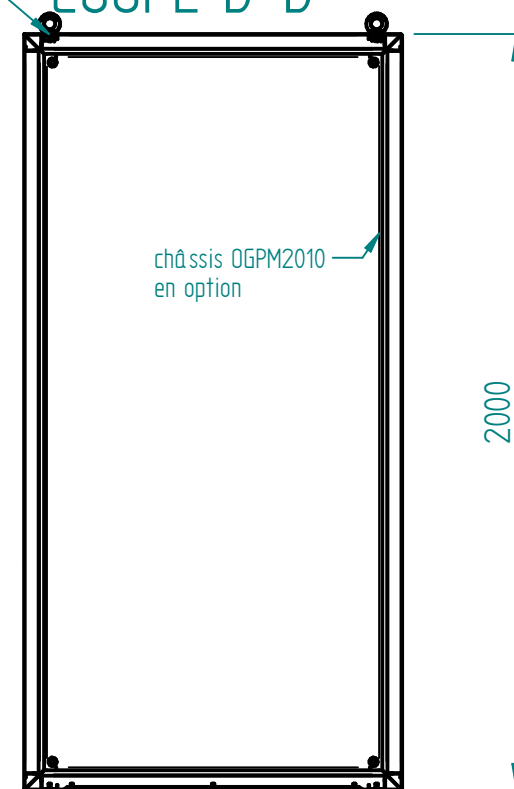

Joint EPDM extrudé 20x11 intérieur porte

A	CERVERA	28/02/19	Création
Ind	Nom	Date	Commentaires
Matière :		Nom du projet : <b>ARM-MONO-2000x1000x500</b>	
Echelle : 1:20	Feuille : 1 / 1	Client :	
		Document n° : <b>AXPM201050 ou AYPM201050</b>	
<b>MARBORE</b>			