

Matière inox 304L ou 316L svt demande client  
 finition microbillée ou peint svt demande client

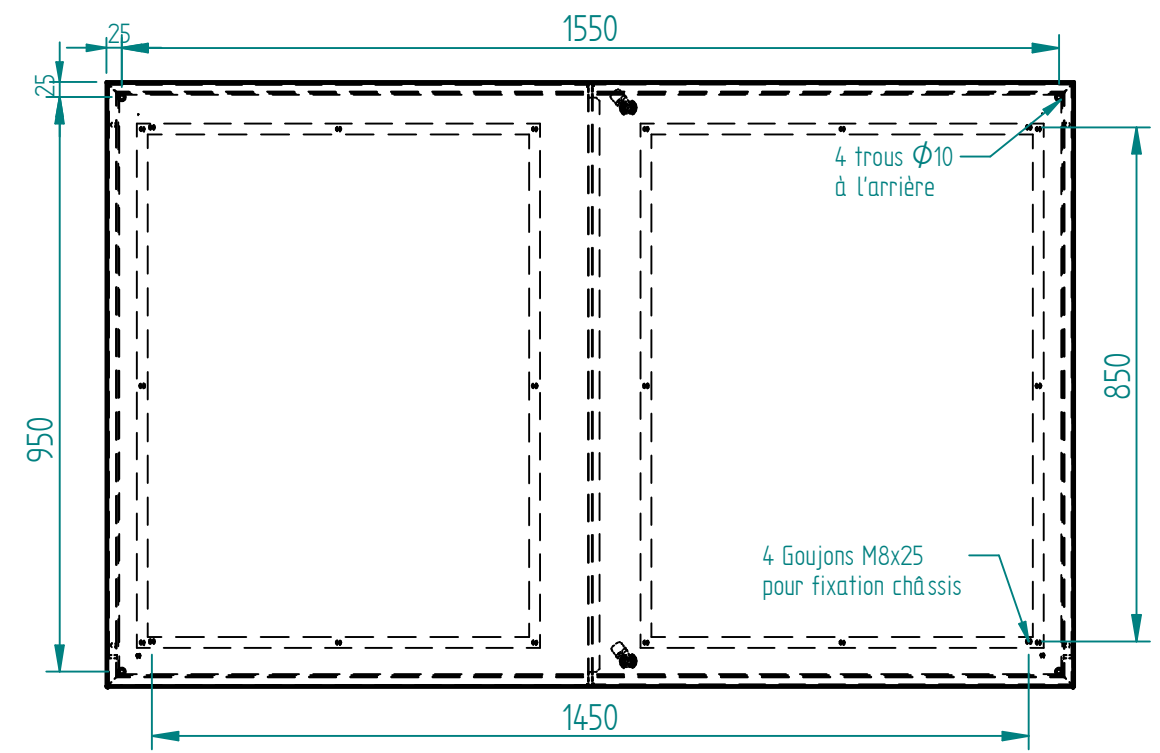

Joint EPDM extrudé 20x11 intérieur porte

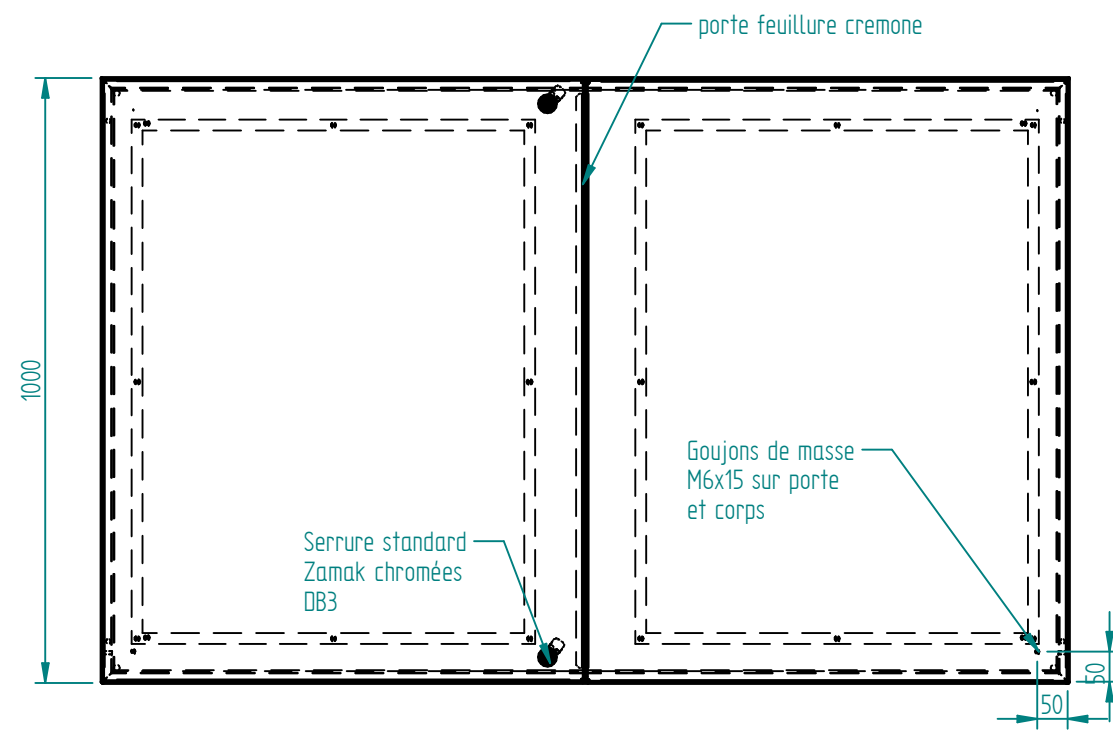
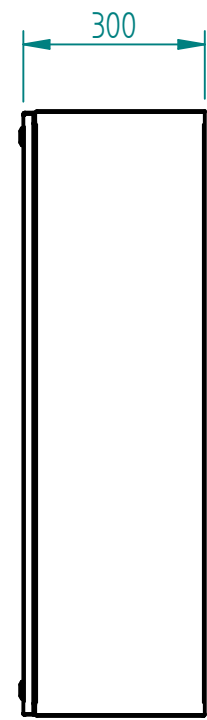
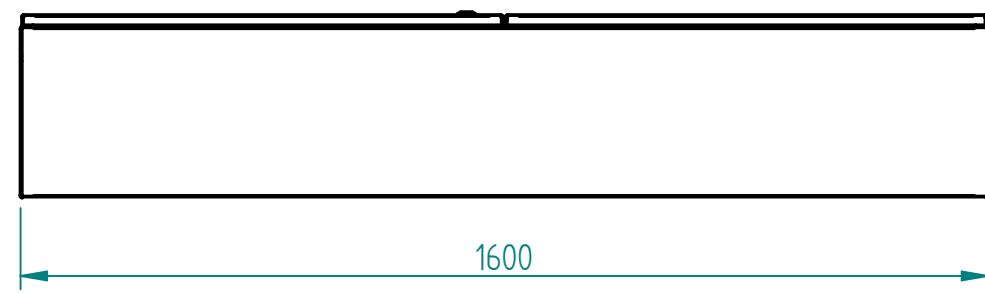
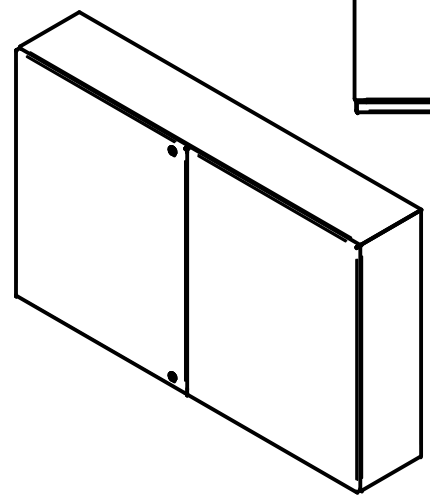
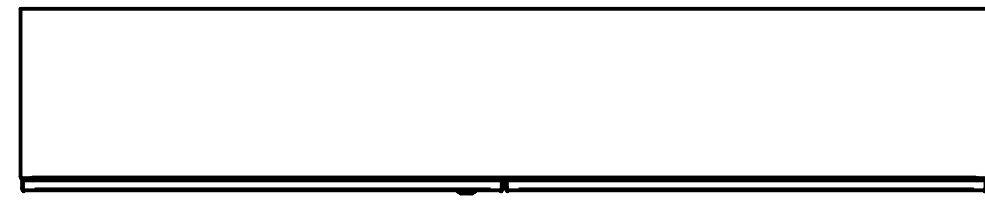

Ind	Nom	Date	Commentaires
Matière :		Nom du projet : <b>COFF-1000x1600x300</b>	
Echelle : 1:12.5	Feuille : 1 / 1	Client :	
		Document n° : <b>CXDN101630 ou CYDN101630</b>	
<b>MARBORE</b>			