

Matière inox 304L ou 316L svt demande client
 finition microbillée ou peint svt demande client

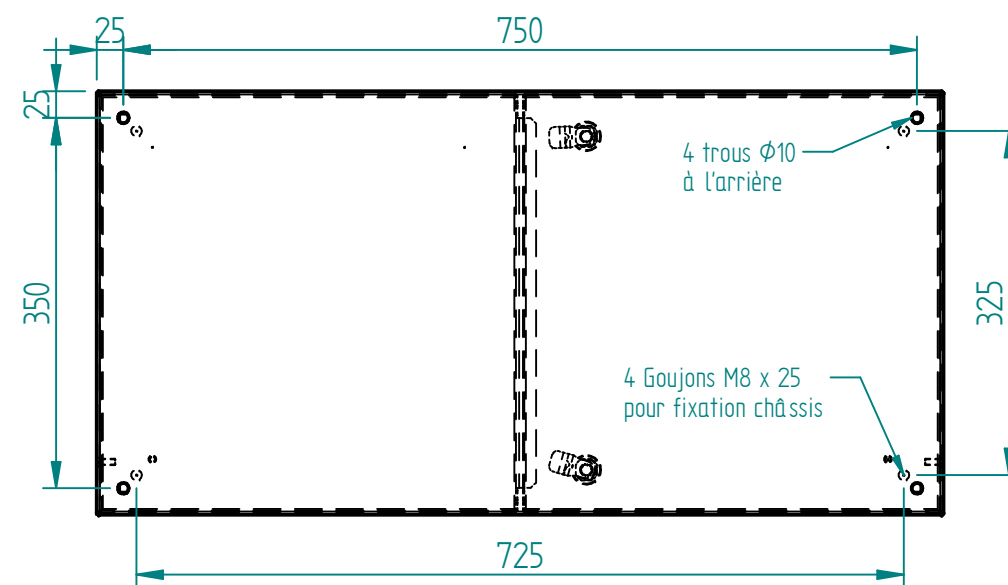

Joint EPDM extrudé 20x11 intérieur porte

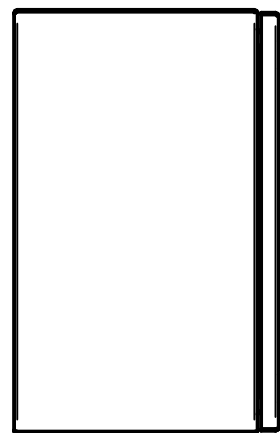
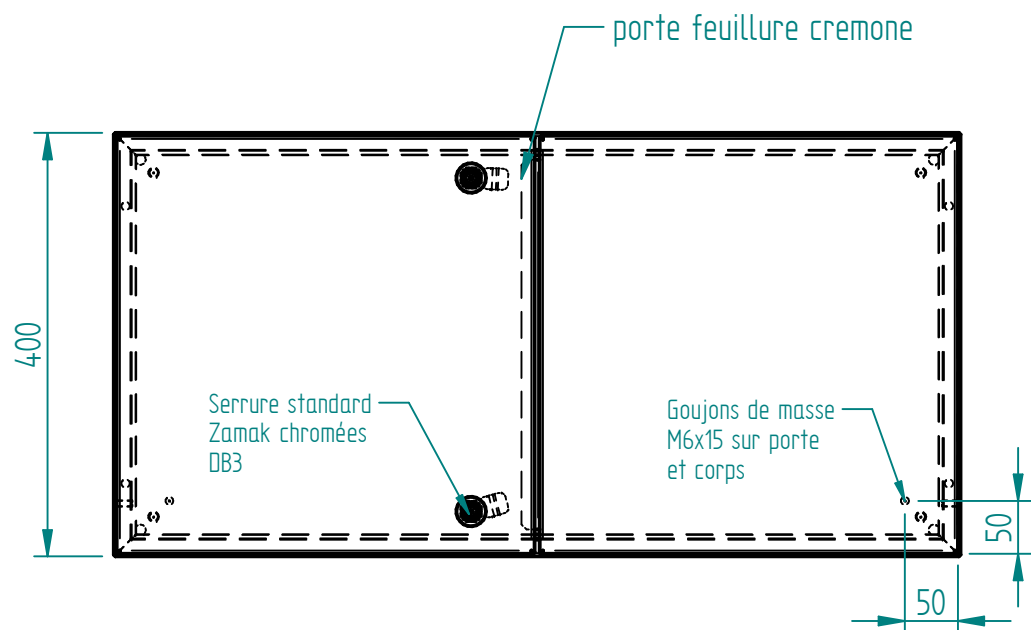
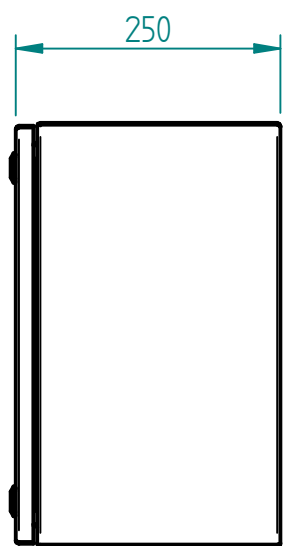
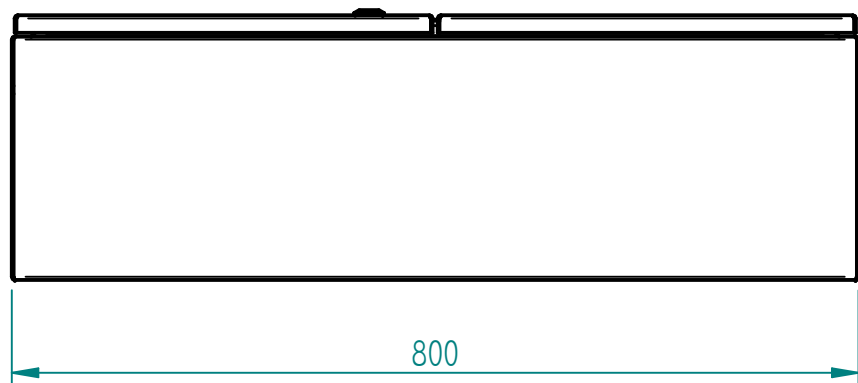
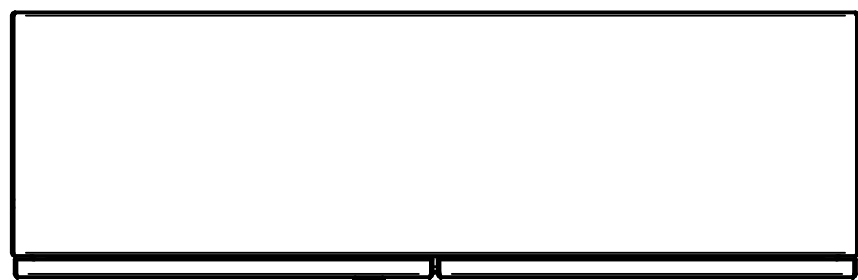
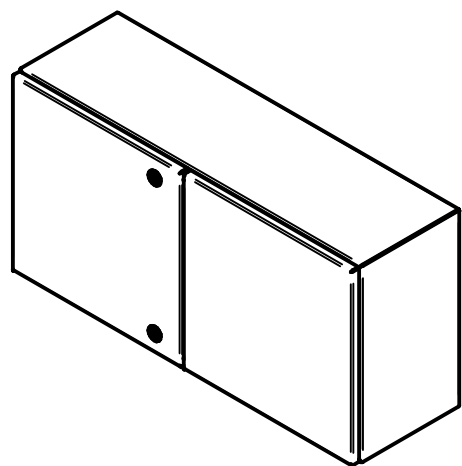

Ind	Nom	Date	Commentaires
Matière :		Nom du projet : COFF-400x800x250	
Echelle : 1:7.14	Feuille : 1 / 1	Client :	
		Document n° : CXDN408025 ou CYDN408025	
MARBORE			