

Matière inox 304L ou 316L svt demande client  
 finition microbillée ou peint svt demande client

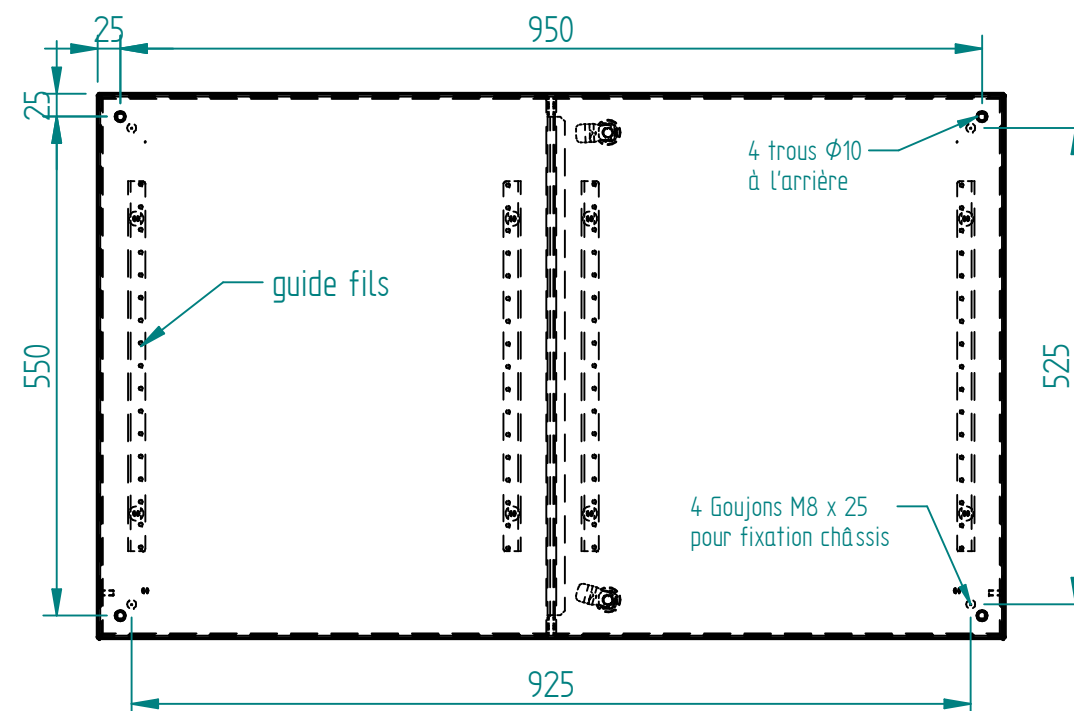

Joint EPDM extrudé 20x11 intérieur porte

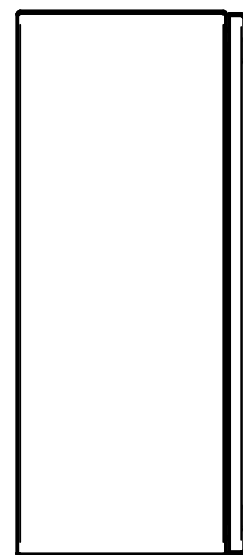
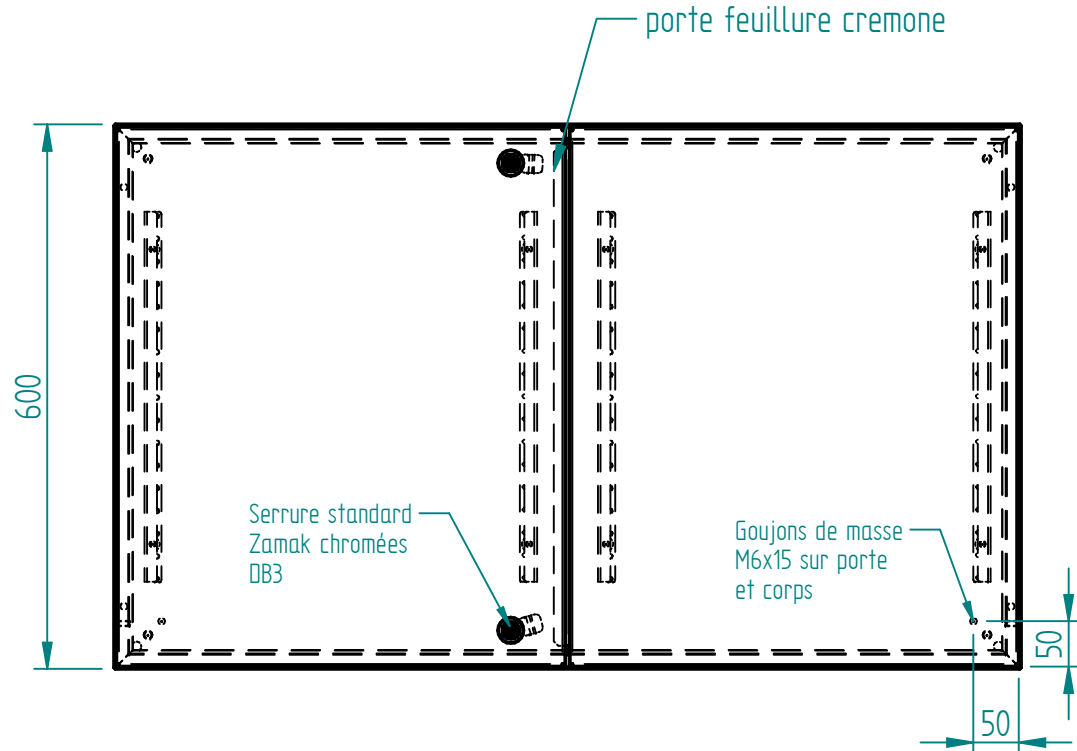
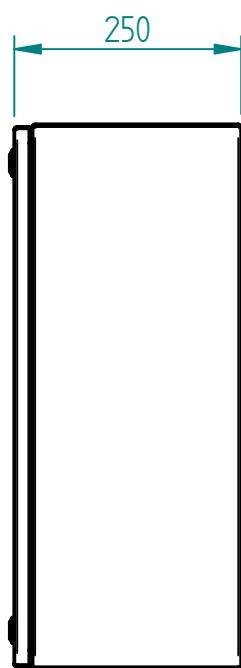
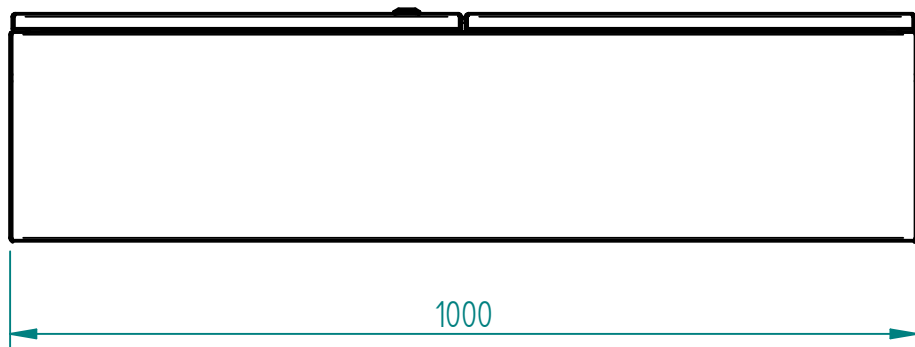
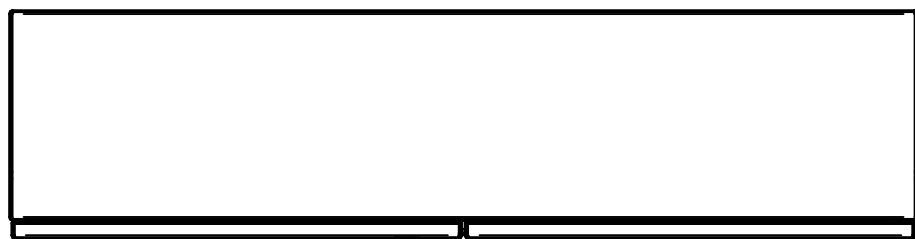
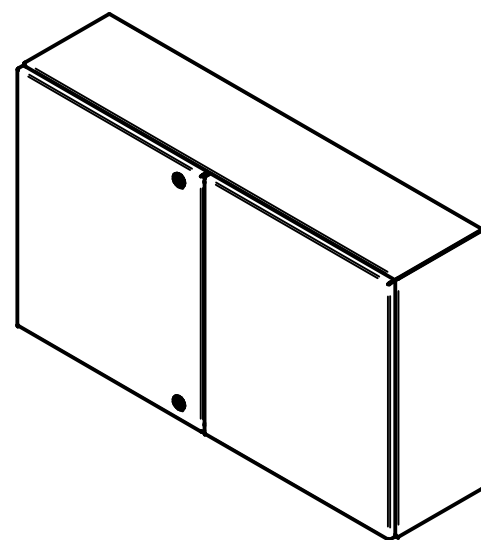

Ind	Nom	Date	Commentaires
Matière :		Nom du projet : <b>COFF-600x1000x250</b>	
Echelle : 1:8.33	Feuille : 1 / 1	Client :	
		Document n° : <b>CXDN601025 ou CYDN601025</b>	
<b>MARBORE</b>			