

Matière inox 304L ou 316L svt demande client
 finition microbillée ou peint svt demande client

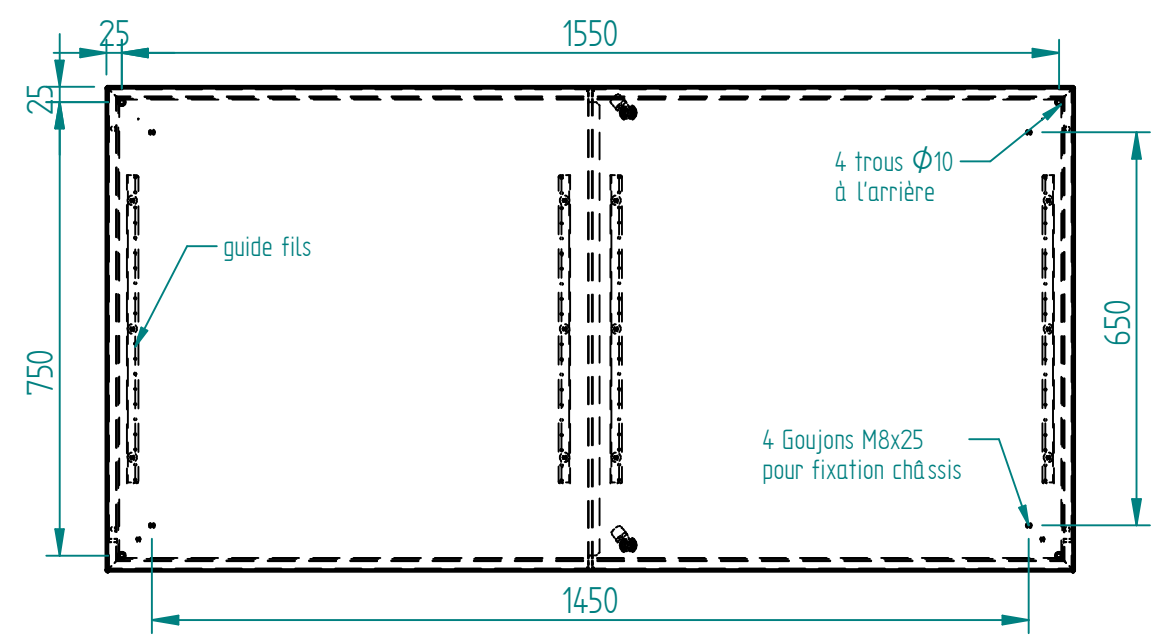

Joint EPDM extrudé 20x11 intérieur porte

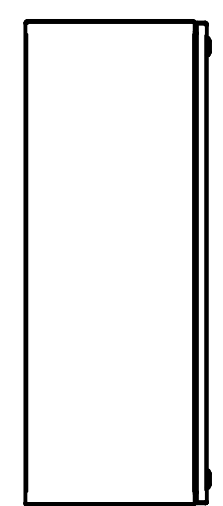
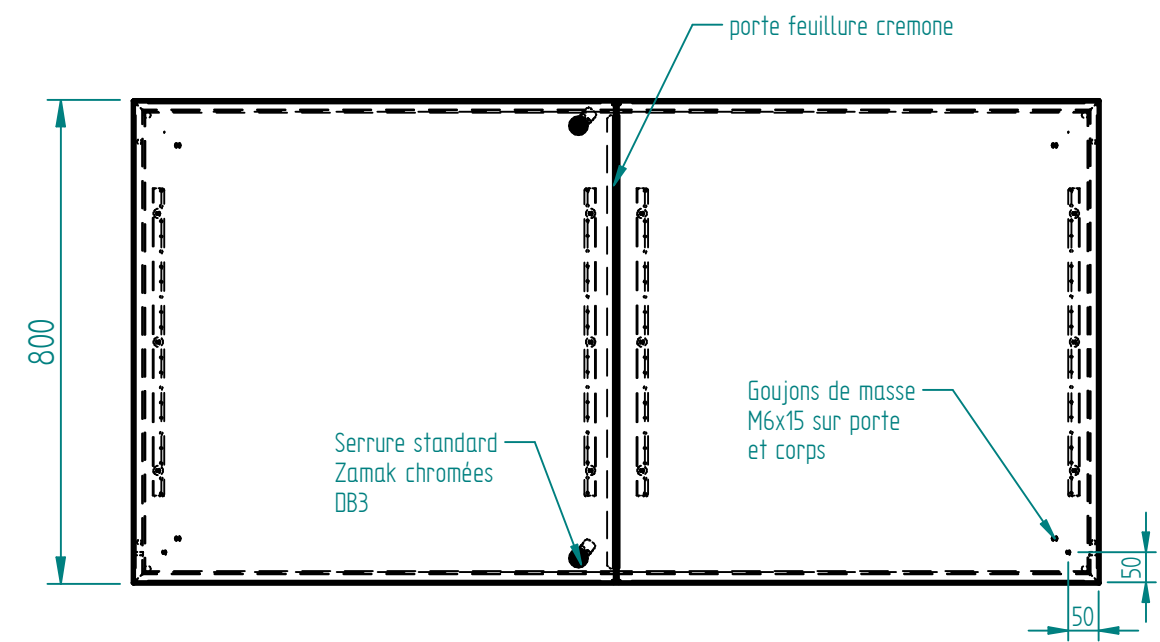
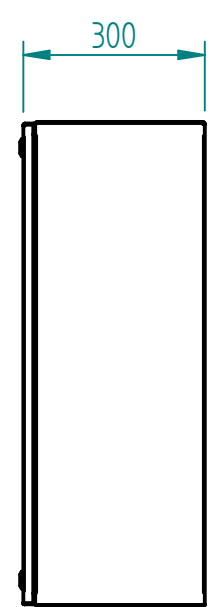
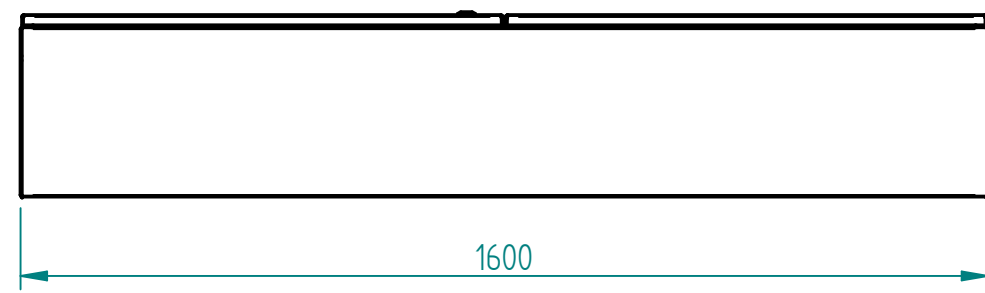
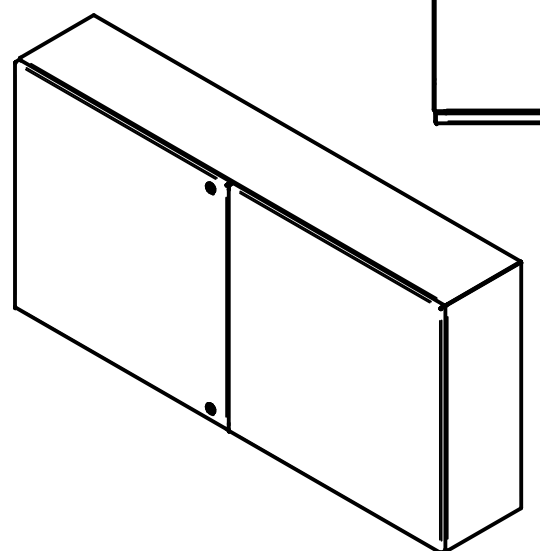

Ind	Nom	Date	Commentaires
Matière :		Nom du projet : COFF-800x1600x300	
Echelle : 1:12.5	Feuille : 1 / 1	Client :	
		Document n° : CXDN801630 ou CYDN801630	
MARBORE			