

COUPE A-A

traverses pour fixation châssis

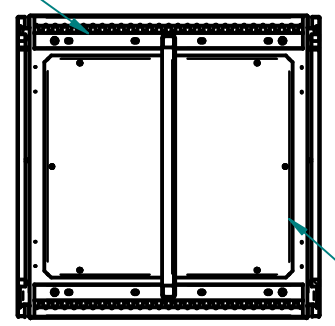

plaque passe cable

Matière inox 304L ou 316L svt demande client
 finition microbillée ou peint svt demande client

Joint EPDM extrudé 20x11 intérieur porte

Socle INOX 316L en option

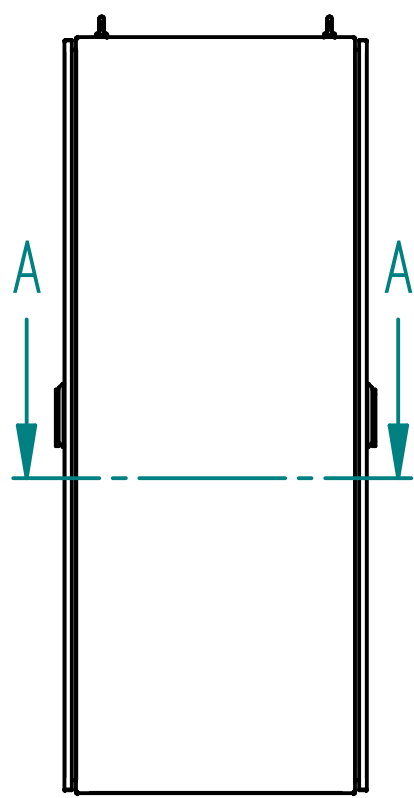
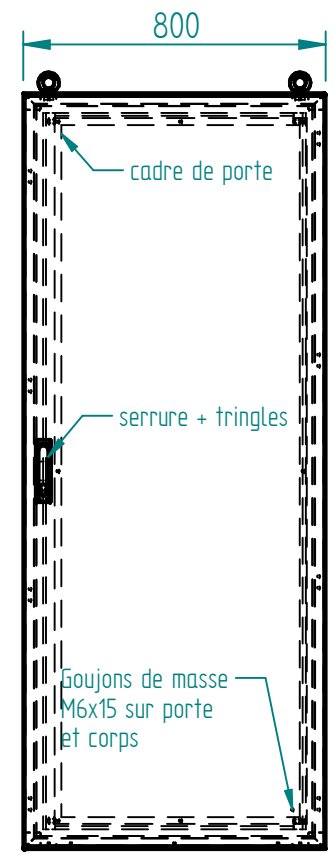
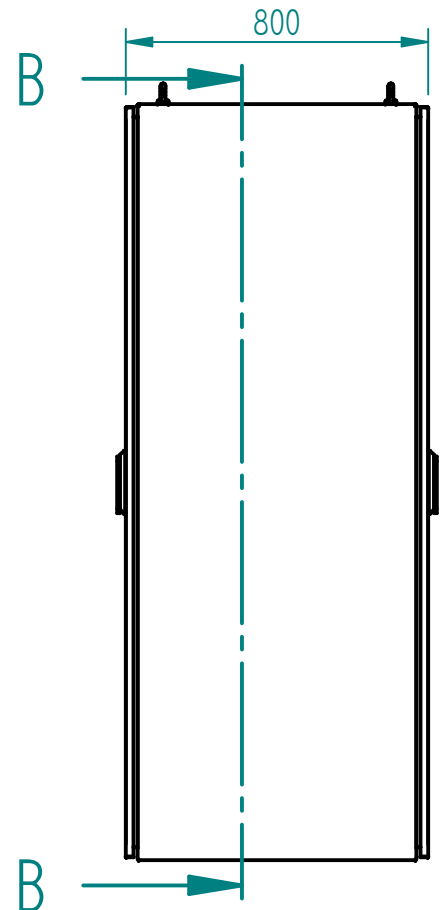

COUPE B-B

anneaux de levage en option

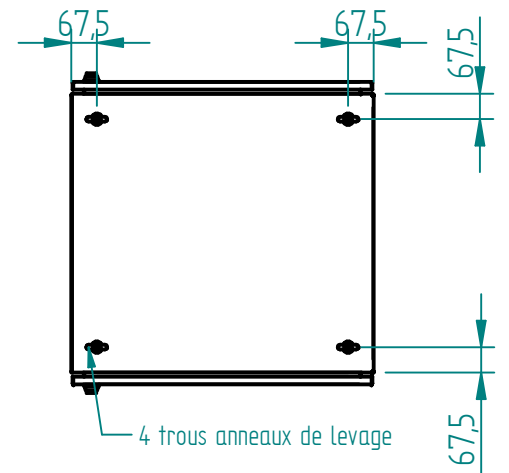
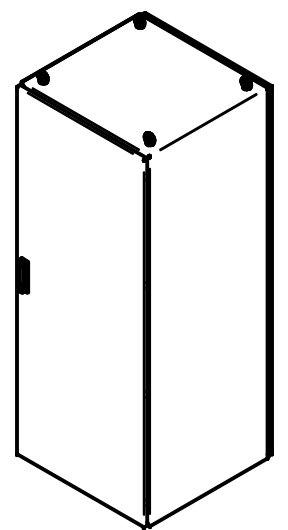
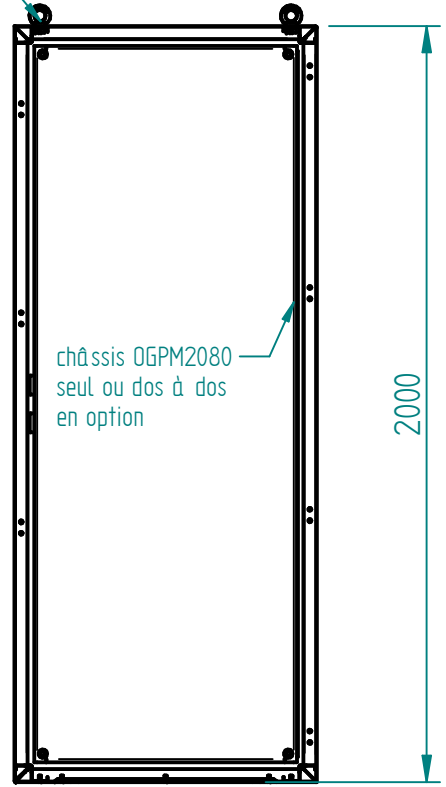

A	CERVERA	18/04/19	Création
Ind	Nom	Date	Commentaires
Matière :		Nom du projet :	
Echelle : 1:20		Feuille : 1 / 1	
		Client :	
MARBORE		Document n° :	
		AXPA208080 ou AYPA208080	